

# ABB Manual Motor Protector Application Guide

Products – Application Guidelines  
UL Regulations for US Market



- 1. Contents**
- 2. Application Pictures**
- 3. Product Overview**
- 7. Applications**
  - a. Basic MMP**
  - b. Combo Motor Starters**
  - c. Group Installation**
  - d. UL508 type E**
- 15. MMP Range**
  - a. MS116**
  - b. MS325**
  - c. MS45x**
  - d. MS49x**
- 19. Catalog Information**
- 25. Smiss Line**



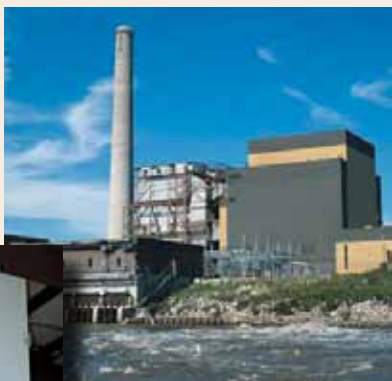

## Manual Motor Protectors from ABB

ABB offers a wide range of Manual Motor Protectors (MMP), and we realize with all the Listings, Rules, and Codes that the What, When, Where, Why and How of MMPs can get complicated. The following information is provided to aid in the proper use of the ABB Type MS MMP and all of their capabilities. Be sure to always follow all national and local codes for your specific application.

The typical combination motor starter usually consists of a Disconnect, Short-Circuit Protective Device, Contactor, and Overload Relay, which operates and protects the motor. A Manual Motor Protector is a manually operated device that provides overload and short-circuit protection for individual motor loads in an All-in-one package.

The ABB Type MS MMPs provide protection against:

- Overload
- Short Circuits
- Phase Failure
- Undervoltage

They are UL/CSA Listed as Manual Motor Protectors, providing Overload Protection in Class 10 or Class 20 and Short-Circuit Protection, for individual motor loads as well as Group Motor applications.

ABB also offers a selection of UL/CSA Listed Self-Protected (Type E) Manual Motor Protectors. These devices eliminate the need for additional Short-Circuit Protection in many applications. When applied according to NEC Article 430-52(c)(6) for individual motor circuits.

Additionally, the ABB Type MS MMP increases the reliability of applications due to the quick reaction time, switching off the motor within 3ms, under short-circuit conditions that could cause motor damage.

The Type MS MMP provides a reliable, cost-efficient solution for motor protection in many Industrial applications, for example:

- Packaging Machines
- Mining
- Saw mills
- Fresh and Waste water treatment
- Conveyor Systems
- Pumps
- HVAC

The ABB Type MS MMPs are a wide range of products providing highly efficient motor protection up to 100 Amps. The short circuit breaking capacity of these devices can reach up to 100 kA depending on the MMP type used, without the need for any special upstream protection.

The MMP device-types have been divided into four frame sizes to ease the selection, coordination, and installation in different applications.

### Switching capabilities of ABB's manual motor starters

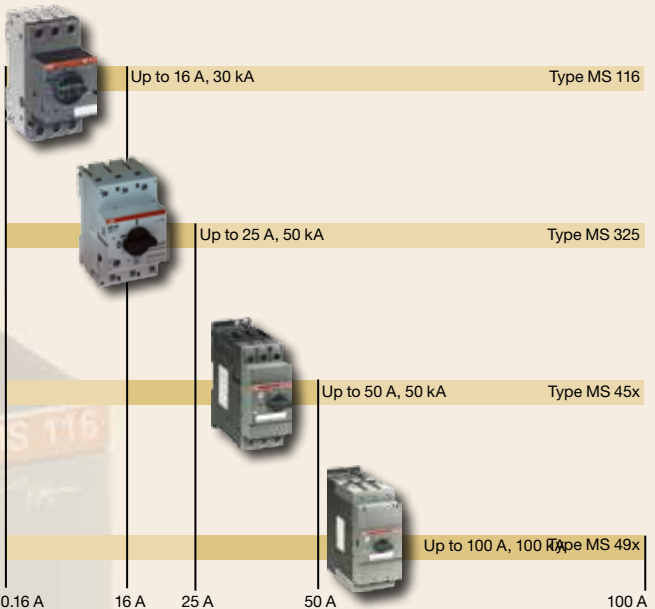

# Manual Motor Starters from ABB

- MS116 ranges up to 16 Amps with a width of only 45mm. It is the smallest in the line with an available top mounted Auxiliary that does not add any additional width. The MS116 is a great choice for space saving applications.
- MS325 ranges up to 25 Amps and has the lowest “energy let through” values in case of a short circuit. The MS325 is ideal for the more demanding application. Available with (Type E)

The MS116 and MS325 can be easily coordinated with the ABB Smisline, Modular power distribution bus system, providing a versatile and flexible means of distributing power to a wide variety of electrical devices. Smisline is excellent for Group Motor Applications and other ABB modular DIN rail products.

- MS45x ranges from 11 – 50 Amps. It is available with all the accessories of the two smaller types, but in two different short-circuit interrupting ranges. It offers overload protection in Class 10 or 20.
- MS49x ranges from 11 – 100 Amps and is our largest MMP. It is available in three model ranges with different Interrupting capacities and Class 10 or 20 overload protection.

The MS45x and the MS49x are your best choice for larger applications, and available with (Type E).

### Technical Data, Overview

Motor starter type	MS116	MS 325	MS 45x	MS 49x
Ie/A	16	25	50	100
ICS/kA	30	50	50	100
Tripping class	10	10	10,20	10,20
Magnetic type only		•	•	•
Disconnect Capability, ref. IEC 60947-1	•	•	•	•

These Manual Motor Protectors are designed to be easily coordinated with various other components from ABB. These components include the A-Line and Miniature contactors as well as our Circuit Breakers and Disconnect Switches. Together with the Manual Motor Protectors MS116, MS325, MS45x, and MS49x these ABB components form coordinated combination starters for a large variety of applications.

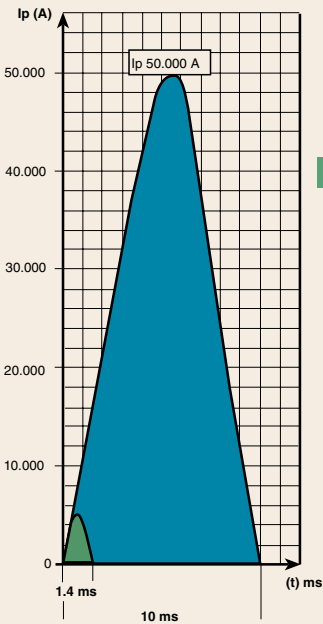

The types MS 325 have the lowest “energy let through”-values on the market in case of short circuits.

This also protects the cables and wirings and provides for high safety.

Manual motor starters must be set to the rated motor demand. Higher current is needed at motor start-up. During the start-up period the manual motor starter will let the current go through and will not trip, following the pertaining international standards and curves for motor start and hold operation.

### MSx Tripping curves

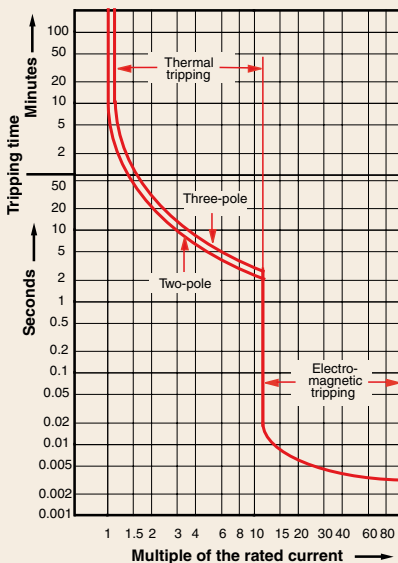

# Combo Motor Starter Information

## Combination Motor Controller

There has been some confusion in the past years concerning the application of motor controllers. UL508A addresses this issue as to what devices make up a motor controller and what kind of options are available. The combination motor controller is a device or combination of devices designed to start and stop a motor by making and breaking the motor current. The controller is capable of interrupting the locked-rotor current of the motor. In the United States, the National Fire Protection Association (NFPA) 70, National Electrical Code (NEC), Article 430 addresses motors, branch-circuit protection, motor overload protection, control circuits, motor controllers, conductors, the combination of these devices and how they relate to one another in regards to protection and sizing.

The combination motor controller generally consists of a circuit disconnecting means; motor branch-circuit, short-circuit and ground-fault protection device; a magnetic or solid state motor controller; and overload relay. The circuit disconnecting means, motor branch-circuit, short-circuit and ground-fault protection device, usually consists of a fusible disconnect or a circuit breaker. The circuit breaker can be either an instantaneous trip or inverse time breaker. The instantaneous trip breaker provides short circuit protection where the inverse time breaker provides both short circuit protection and overload protection. The magnetic motor controller is generally referred to as a contactor. The motor controller makes or breaks the motor current. The overload relay provides protection from overload conditions. Auxiliary pilot devices such as pushbuttons and selector switches, whether mounted on the unit or mounted remotely, are used to energize or de-energize the motor controller. Pilot lights are used to show equipment status. A typical combination motor controller using a contactor and overload relay



along with the different combinations of circuit disconnecting means is shown in Figure 1:

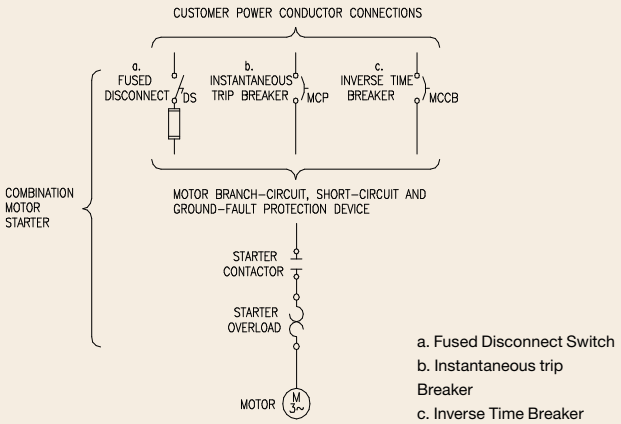

Figure 1

ABB offers combination motor controllers that are UL rated from fractional HP to 900 HP at 460/480 volts AC. Other HPs and voltage ratings are available. The maximum short circuit rating using the fused disconnect is 200 kA at 600 volts AC. The maximum short circuit ratings using the instantaneous trip breakers are shown in Table 1.

Contactor	kA at 480 volts AC	kA at 600 volts AC
A9	35	35
A12	35	35
A16	35	•
A26	35	35
A30	65	•
A40	65	•
A50	85	35
A63	85	•
A75	85	•
A95	85	35
A110	85	35
A145	85	10
A185	85	10
A210	85	18
A260	85	18
A300	85	18
A400	85	Consult Factory
A460	85	Consult Factory
A580	85	Consult Factory
A750	85	Consult Factory
A1350	Consult Factory	Consult Factory
A1650	Consult Factory	Consult Factory

Table 1

# Manual Motor Protector

A manual controller is defined by UL 508 as a hand-operated switching device whose contacts are controlled by the position of a mechanical actuator. It may be provided with an instantaneous trip element for short circuit protection only and optionally provided with an overload relay.

The ABB manual motor protector (MMP) is a device that replaces the magnetic contactor and overload relay in a motor controller. The MMP uses an adjustable bimetallic for overload protection. The bimetallic has four heaters, one in each phase for quick acting overload protection and one for ambient compensation which negates the effects of ambient temperature. The upstream short-circuit and overcurrent protection is required to complete the starter. When used by itself, the MMP is a simple local manual control device for starting the motor or with a contactor, remote control of the motor starting is available. ABB offers several MMPs rated from fractional HP up to 75 HP at 480 volts AC. The MMP is a DIN rail mountable device that saves space and installation time.

The two installation options are shown in Figure 2. The first does not have the additional contactor and the second has the additional contactor for remote control applications. The contactor can be closed and opened from remote controls such as a standard push button station, switch or output from a PLC.

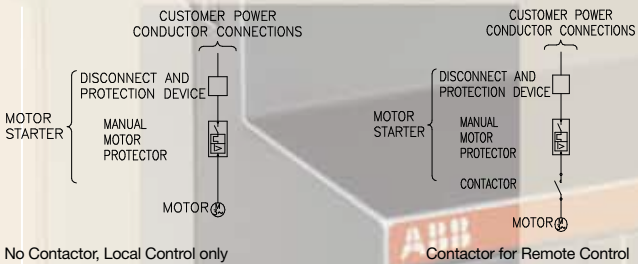

Figure 2

The maximum kAIC rating at 600 volts AC is shown in Table 2.

<b>MMP</b>	<b>KAIC at 600 volts AC</b>
MS325	50
MS450	50
MS451	50
MS495	50
MS496	100
MS497	100

Table 2

## UL 508 TYPE E Combination Motor Controllers

In recent years, UL added the Type E combination motor controller to its list of combination motor controllers in section 508, Industrial Control Equipment. The Type E controller is a manual self-protected combination motor controller that provides both overload and short-circuit protection in a compact device. This design DOES NOT require an upstream circuit breaker or fuses. The Type E controllers are designed to have a disconnect means, branch circuit protection, motor control and motor overload is a single device, the same features required on a combination motor controller. Some of the other requirements are the disconnect will include a means to be locked in the off position, it will open all ungrounded supply conductors and no one pole can be opened independently. The enclosure door is to be interlocked with the disconnect so when the disconnect is closed, the door cannot be opened and if the door is open, the disconnect cannot be closed; unless there is a defeat mechanism that requires tools to operate and is self-restoring when the door is closed. The Type E controller will have a visible means indicating whether the unit has tripped from an overload or a short-circuit. The Type E controller does not have replaceable components and a minimum surface and air spacing is required between the line side terminals.

The NEC Article 430.52(C)(6) also addresses Self-Protected Combination Controllers. The NEC states that a listed self-protected combination controller can be used in place of fuses or circuit breakers and that the adjustable instantaneous-trip settings for Design E motors or Design B energy efficient motors shall not exceed 1700 percent of the full-load motor current and shall not exceed 1300 percent for other design motors.

ABB has several MMPs that have been tested for UL 508 Type E construction, these include the MS325, MS45x series and the MS49x series. The MMPs have an optional short circuit indicating module that will provide a positive indication to differentiate between the short circuit trip and the overload trip. The optional line side terminal shroud provides the minimum required spacing between the live parts over the surface and through the air, and is touch safe. The MMPs have auxiliary devices that can be added, such as auxiliary contacts, shunt trip and UV release. The MS325 and MS450 series also have line side busbar and through the door handles as options.

The MS325, MS450, MS495 and MS497 provide overload trip Class 10 protection. The MS451 and MS496 provide overload trip Class 20 protection. Overload trip Class 10 will trip in less than 10 seconds at 6 times the trip current setting and the Class 20 will trip in less than 20 seconds at 6 times the trip current settings. The rated operating current ranges from 0.10 amps on the MS325 to 100 amps on the MS49x series. The MMP Type E controller would be connected in a circuit as shown in Figure 3.

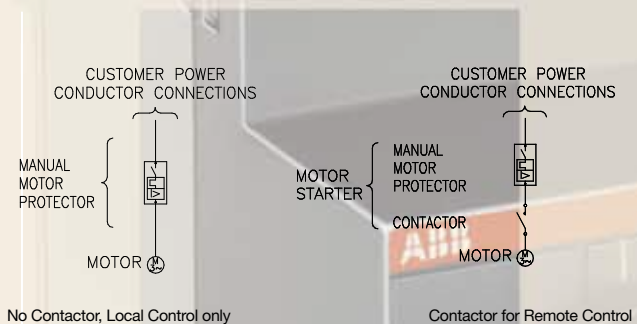

Figure 3

The use of the contactor is only required if remote control will be used for starting and stopping the motor. The use of an MMP reduces panel space by eliminating the need for separate circuit disconnecting means, motor branch-circuit, short-circuit and ground-fault protection device, a magnetic or solid state motor controller, and overload relay. Installing a single device is quicker and eliminates complicated wiring.

The Type E combination motor controller is a compact device that can be used where space is limited. An example of the use of a Type E combination motor controller would be a remote booster pump station. A contactor could be added for remote PLC control.

## **Group Motor Applications: NEC 430-53**

A group motor application is defined as two or more motors or one or more motors and other loads connected to the same branch circuit. The NEC 430-53 allows one or more motors and other loads to be connected to the same branch circuit under certain conditions. In the past, when these applications were fed from a single branch circuit, each motor controller had to have included a circuit disconnecting means; motor branch-circuit, short-circuit and ground-fault protection device; a magnetic or solid state motor controller; and overload relay. These devices were mounted directly to the panel and then wired together. The addition of the Type E starter to UL 508 allows the MMP to replace those devices when installed in a factory assembled panel. Multiple MMPs can be mounted on a DIN rail and connected using the optional bus bar connector kit, which eliminates wiring on the line side between the MMPs. Less time and space is needed making the panels faster to assemble and smaller.

Group motor applications require consideration of the motor HPs being used in accordance with NEC Article 430-53(D) Single Motor Taps and either Articles 430-53(A) Not Over 1 Horsepower or 430-53(B) If Smallest Rated Motor Protected or 430-53(C) Other Group Installations.

Article 430-53(A) discusses multiple motors not over 1 HP each and limited to 20 amps at 120 VAC or 15 amps at 600 VAC or less. Article 430-53-(B) discusses the smallest motor protective device protecting additional motors without nuisance tripping. Article 430-53(C) discusses factory assemblies with overload, short-circuit and ground-fault protections devices. Article 430-53(D) discusses the conductor sizes used in group applications. Therefore, the MMP when applied using NEC 430.53 (C) and NEC 430.53 (D) (3) provides flexibility in constructing multiple motor starter control panels. The control panels can now have a single branch-circuit, short-circuit and ground-fault protective device instead of having a device for each motor starter.

One of the main points that Article 430-53(D) addresses is the limitation on conductor sizing. The conductor between the MMP and the motor cannot be less than 1/3rd the rating of the branch circuit conductor and they are not more than 7.5 m (25 ft) long while being protected from physical damage; or the conductor from the branch short-circuit and ground-fault protective device to the MMP does not have a rating less than 1/10th the rating of the branch short-circuit and ground-fault protective device. The conductor shall be protected from physical damage, enclosed by the motor controller enclosure or by a raceway, and be not more than 3 m (10 ft) long; or shall have an ampacity not less than the branch circuit conductor.

In any case, the conductor from the MMP to the motor shall be sized in accordance with NEC Article 430-22. Where the motors have a wide range of HP, it may be best to split the motors into two or more group applications where each group can more closely match the conductor to the branch short-circuit and ground-fault protective device.

The short circuit ratings for the MS325 in group applications range from 5 kA to 85 kA when using circuit breakers or fuses. The short circuit ratings for the MS450/451 and MS495/496/497 in group applications range from 30 kA to 50 kA at 440 VAC when using fuses.

As mentioned above, the MMP requires manually switching the disconnecting device to the ON or OFF position to start or stop the motor, which does not require a contactor. Figure 4 shows this type of application.

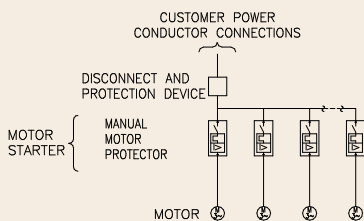

Figure 4

When the control philosophy requires the motors to start and stop at different times during a sequence or from a remote device, contactors will need to be added to accomplish this function. The contactors can be closed or opened from the panel or from a remote device, such as a standard push button station, switch or output from a PLC. Figure 5 shows this type of application.

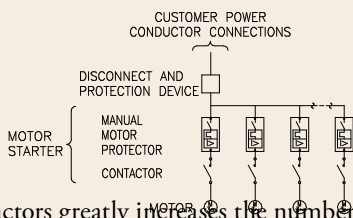

Figure 5

Adding contactors greatly increases the number of applications where the MMP can be utilized. ABB has several contactor sizes that can be used, from the miniature contactor to the NEMA size and rated contactor.

Examples for using the MMPs in group applications would be a mechanical bar screen and belt filter press control panels. The typical mechanical bar screen or belt filter press has 3 to 4 motors generally less than 10 horsepower each which work in conjunction with each other. Other examples would include a lime storage tank and conveyor distribution system. The lime storage tank could have a dust collector motor, shaker motor and screw conveyor motor. The conveyor distribution system could have several conveyor motors, which could control the belt or screw direction and conveyor position.

# General Info MMP type MS116

- Suitable for 3phase motors up to 10 HP @ 480V
- AMP range from 0.16-16A
- UL listed & CSA certified for Group Motor Installation
- Wide range of accessories
- Small width (45mm)Arguments
- Save space
- High short circuit capacity
- Adjustable Overload protection
- Short circuit protection
- Phase failure detection



## Technical data

Rated current: 0.16-16A

Rated operating voltage:  
max. 600V

Tripping class:10

Max. kA IC @ 600V 30kA

Mechanical Life Time:  
100,000 switches



## Accessories

- **Auxiliary contacts (side & front)**
- **Under-voltage release**
- **Shunt trips**
- **Bell alarm**
- **Locking device**
- **Through the door operator**
- **Enclosures**
- **Direct contactor mounting adapter**
- **Suitable for Smissline busbar system up to 200A**
- **Busbar system**



## General Info MMP type MS325

- Suitable for 3phase motors up to 15 HP @ 480V
- AMP range from 0.16-25A
- UL listed & CSA certified for Group Motor Installation
- Wide range of accessories
- Save space
- High short circuit capacity
- Adjustable Overload protection
- Short circuit protection
- Phase failure detection
- UL508 (type E) listing available



### *Technical data*

Rated current:  
0.16-25A

Rated operating voltage:  
max. 600V

Tripping class: 10

Max. kA IC @ 600V 50kA

Mechanical Life Time:  
100,000 switches

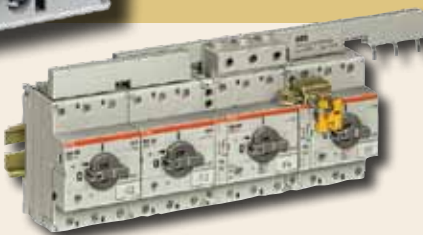

### *Accessories*

- **Auxiliary contacts (side & front)**
- **Under-voltage release**
- **Shunt trips**
- **Bell alarm**
- **Locking device**
- **Through the door operator**
- **Enclosures**
- **Direct contactor mounting adapter**
- **Suitable for Smissline busbar system up to 200A**
- **Busbar system**

# General Info MMP type MS45x

- Suitable for 3phase motors up to 40 HP @ 480V
- AMP range from 11-50A
- UL listed & CSA certified for Group Motor Installation
- Wide range of accessories
- Save space
- High short circuit capacity
- Adjustable Overload protection
- Short circuit protection
- Phase failure detection
- UL508 (type E) listing available



## *Technical data*

Rated current: 11-50A

Rated operating voltage:  
max. 600V

Tripping class:10/20

Max. kA IC @ 600V 50kA

Mechanical Life Time:  
100,000 switches

## *Accessories*

- **Auxiliary contacts (side & front)**
- **Under-voltage release**
- **Shunt trips**
- **Locking device**
- **Through the door operator**
- **Enclosures**
- **Direct contactor mounting adapter**
- **Suitable for Smissline busbar system up to 200A**
- **Busbar system**

## General Info MMP type MS49x

- Suitable for 3phase motors up to 75 HP @ 480V
- AMP range from 11-100A
- UL listed & CSA certified for Group Motor Installation
- Wide range of accessories
- Save space
- High short circuit capacity
- Adjustable Overload protection
- Short circuit protection
- Phase failure detection
- UL508 (type E) listing available



### *Technical data*

Rated current:  
11-100A

Rated operating voltage:  
max. 600V

Tripping class: 10/20

Max. kA IC @ 600V 100kA

Mechanical Life Time:  
100,000 switches

### *Accessories*

- **Auxiliary contacts (side & front)**
- **Under-voltage release**
- **Shunt trips**
- **Locking device**
- **Enclosures**
- **Direct contactor mounting adapter**
- **Suitable for Smissline busbar system up to 200A**

# Manual Motor Protector MS116 Numbers



MS116, BEA16/116, A12-30-10-84



MS116, BEA7/116, B7C-1



HK1-11



HKF1-11



UA1-120



AA1-110



BEA7/116



12644

## Thermal setting range (Amps)

240V

0.10 - 0.16	-
0.16 - 0.25	-
0.25 - 0.40	-
0.40 - 0.63	-
0.63 - 1.0	-
1.0 - 1.6	-
1.6 - 2.5	-
2.5 - 4.0	1/8
4.0 - 6.3	1/4
6.3 - 10	1/2
8.0 - 12	1/2
10.0 - 16	1

## ACCESSORIES FOR MS116

### DESCRIPTION

- 1 NO & 1 NC Auxiliary contact blocks, side mount
- 2 NO Auxiliary contact blocks, side mount
- 2 NC Auxiliary contact blocks, side mount

- 1 NO & 1 NC Auxiliary contact blocks, front mount

- 1 NO & 1 NC Bell alarm contact blocks
- 2 NO Bell alarm contact blocks
- 2 NC Bell alarm contact blocks

- 24VAC Undervoltage trip
- 48VAC Undervoltage trip
- 60VAC Undervoltage trip
- 120VAC Undervoltage trip
- 230VAC Undervoltage trip
- 400VAC Undervoltage trip
- 415VAC Undervoltage trip

- 24VAC Shunt trip
- 110VAC Shunt trip
- 200 - 240VAC Shunt trip
- 350 - 415VAC Shunt trip

- Busbar for direct mounting of contactors B6/B7
- Busbar for direct mounting of contactors A9/A12/A16
- Busbar for direct mounting of contactors A26

- Gray Enclosure with black handle, IP64
- Gray Enclosure with red handle, IP64
- Gray Enclosure with clear cover, 4 poles, IP55
- Gray Enclosure with clear cover, 6 poles, IP55

**3-phase horsepower ratings****Catalog Number****480V****600V**

-	-	MS116-0.16
-	-	MS116-0.25
-	-	MS116-0.40
-	-	MS116-0.63
1/2	1/2	MS116-1.0
3/4	3/4	MS116-1.6
1	1.5	MS116-2.5
2	3	MS116-4.0
3	5	MS116-6.3
5	7.5	MS116-10
7.5	10	MS116-12
10	10	MS116-16

**Catalog Number**

HK1-11  
HK1-20  
HK1-02

HKF1-11

SK1-11  
SK1-20  
SK1-02

UA1-24  
UA1-48  
UA1-60  
UA1-120  
UA1-230  
UA1-400  
UA1-415

AA1-24  
AA1-110  
AA1-230  
AA1-400

BEA7/116  
BEA16/116  
BEA26/116

OTPA116L2P1  
OTPA116A2P1  
12644  
12646

# Manual Motor Protector MS325

## Thermal setting range (Amps)

240V



MS325

UL 580 Type E



MS325, BEA26/325, A26-30-10-84, S3-M3, CK-11



MS325-HK11



MS325-SK10



MS325-UA110



MS325-AS



BEA16/325



OTPA116A2P1

0.10 - 0.16	-
0.16 - 0.25	-
0.25 - 0.40	-
0.40 - 0.63	-
0.63 - 1.0	-
1.0 - 1.6	-
1.6 - 2.5	1/2
2.5 - 4.0	1
4.0 - 6.3	1.5
6.3 - 9.0	2.5
9.0 - 12.5	3
12.5 - 16	5
16 - 20	5
20 - 25	7.5

## ACCESSORIES FOR MS325

### DESCRIPTION

1 NO & 1 NC Auxiliary contact blocks, side mount  
2 NO Auxiliary contact blocks, side mount  
2 NC Auxiliary contact blocks, side mount

1 NO & 1 NC Auxiliary contact blocks, front mount  
2 NO Auxiliary contact blocks, front mount

1 NO Bell alarm contact blocks  
1 NC Bell alarm contact blocks

24VAC Undervoltage trip  
48VAC Undervoltage trip  
60VAC Undervoltage trip  
120VAC Undervoltage trip  
230VAC Undervoltage trip  
400VAC Undervoltage trip  
415VAC Undervoltage trip  
480VAC Undervoltage trip

110 - 240VAC/DC Shunt trip  
24 - 60VAC/DC Shunt trip

Busbar for direct mounting of contactors B6/B7  
Busbar for direct mounting of reversing contactors VB6/VB7  
Busbar for direct mounting of contactors A9/A12/A16  
Busbar for direct mounting of contactor A26

Gray Enclosure with black handle, IP64  
Gray Enclosure with red handle, IP64  
Gray Enclosure with clear cover, 4 poles, IP55  
Gray Enclosure with clear cover, 6 poles, IP55

Line Side infeed block - required for UL508 type E  
Short circuit trip signal - required for UL 508 type E

3-phase horsepower ratings		Catalog Number
480V	600V	
-	-	MS325-0.16
-	-	MS325-0.25
-	-	MS325-0.40
-	-	MS325-0.63
1/2	1/2	MS325-1.0
3/4	3/4	MS325-1.6
1	1.5	MS325-2.5
2	3	MS325-4.0
3	5	MS325-6.3
5	7.5	MS325-9.0
7.5	10	MS325-12.5
10	10	MS325-16
10	15	MS325-20
15	20	MS325-25

**Catalog Number**

MS325-HK11  
MS325-HK20  
MS325-HK02

MS325-HKF11  
MS325-HKF20

MS325-SK10  
MS325-SK01

MS325-UA24  
MS325-UA48  
MS325-UA60  
MS325-UA110  
MS325-UA230  
MS325-UA400  
MS325-UA415  
MS325-UA480

MS325-ST110  
MS325-ST24

BEA7/325  
MS325-VB7  
BEA16/325  
BEA26/325

OTPA325B2P1  
OTPA325A2P1  
12644  
12646

S3-M3  
CK-11

# Manual Motor Protection MS45x / MS49x



MS495, BEA110/495, A95-30-11-84



HKS4-11



HK4-11



UA4-120



AA4-110



BEA75/495



SK4-11

## Thermal setting range (Amps)

	230V
11 - 16	5
14 - 20	7.5
18 - 25	10
22 - 32	10
28 - 40	15
36 - 45	15
40 - 50	20
11 - 16	5
14 - 20	7.5
18 - 25	10
22 - 32	10
28 - 40	15
36 - 50	20
45 - 63	25
57 - 75	25
70 - 90	30
80 - 100	40

## ACCESSORIES FOR MS45x / MS49x

DESCRIPTION
1 NO & 1 NC Auxiliary contact blocks, side mount 2 NO Auxiliary contact blocks, side mount 2 NC Auxiliary contact blocks, side mount
1 NO & 1 NC Auxiliary contact blocks, front mount 1 CHANGEOVER Auxiliary contact blocks, front mount
110 - 120VAC Undervoltage trip 208VAC Undervoltage trip 230 - 240VAC Undervoltage trip 400VAC Undervoltage trip 480VAC Undervoltage trip
Voltage continuous 50 - 60 Hz 20 - 24 Shunt trip 30 - 110 210 - 240 350 - 415
MS450 Busbar for direct mounting of contactors A30/A40 MS450 Busbar for direct mounting of contactor A50 MS497 Busbar for direct mounting of contactors A50/A63/A75 MS497 Busbar for direct mounting of contactors A95/A110
Short circuit trip 1NO & 1NC - required for UL508 Type E applications
MS49x Type E Terminal - required for UL508 Type E applications



**3-phase horsepower ratings****Catalog Number****480V****575V**

10	15	MS450-16
15	20	MS450-20
20	25	MS450-25
25	30	MS450-32
30	40	MS450-40
30	40	MS450-45
40	50	MS450-50
10	15	MS497-16
15	20	MS497-20
20	25	MS497-25
25	30	MS497-32
30	40	MS497-40
40	50	MS497-50
50	60	MS497-63
60	75	MS497-75
75	100	MS497-90
75	100	MS497-100

**Catalog Number**

HKS4-11  
HKS4-20  
HKS4-02

HK4-11  
HK4-W

UA4-120  
UA4-208  
UA4-240  
UA4-400  
UA4-480

Voltage 5 sec. Max.50 - 60 Hz, DC  
20 - 70 Shunt trip  
70 - 190  
190 - 330  
330 - 500

AA4-24  
AA4-110  
AA4-240  
AA4-415

BEA40/450  
BEA50/450  
BEA75/495  
BEA110/495

SK4-11

DX495

# ABB -SMISLINE- Modular Power Distribution Bus System



## Description

- The smissline power distribution bus system provides a versatile and flexible means of distributing power to a wide variety of electrical devices. Ideal for group motor installations and ABB modular DIN rail products
- Hot swappable socket mounted components.
- Individual devices may be turned off and safely removed without turning off power to the whole bus.
- Bus system “Starter kits” available in various lengths, can also be easily cut down for custom installations.
- Busbar rated 100A when end fed and up to 200A when center fed. Main power feed terminals may be installed anywhere along the bus system.
- Individual bus stab adapters are available in L1, L2, L3 and N phase connections; they can be connected together to form multi-pole units. Unwired modules are available where bus connection is not required. 18mm width.
- Snap-on installation. No tools required to install or remove bus mounted components.
- System can be DIN rail or base mounted.
- Bus covers protect unused portions of the bus from accidental contact providing total bus isolation and IP20 finger safe protection.
- Reputable history of performance and reliability.
- UL508 Recognized, UL File No. E222110.

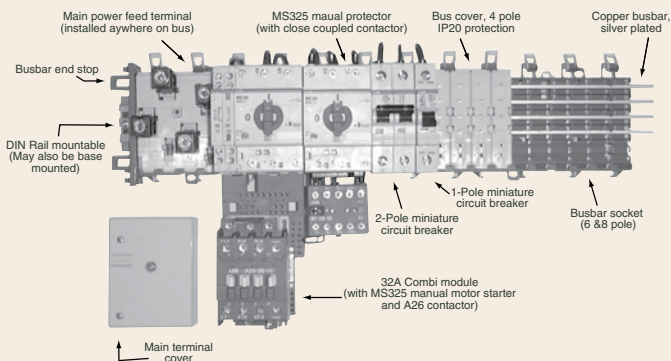
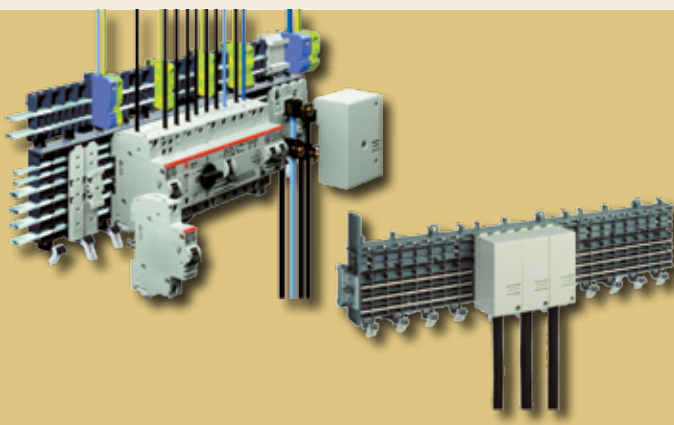

**Standard starter kits** — Each kit includes sockets, bus bar & end stops. Busbar is installed.

Number of modules (module is 0.71" or 18mm)	Assembly Length (inches)	Phases	Catalog Number
24	17.0	3P	ZLS750
		3P+N	ZLS751
32	22.7	3P	ZLS752
		3P+N	ZLS753
40	28.4	3P	ZLS754
		3P+N	ZLS755
48	34.0	3P	ZLS756
		3P+N	ZLS766
64	45.4	3P	ZLS767
		3P+N	ZLS766
80	56.8	3P	ZLS758
		3P+N	ZLS759

## ZLS - BSK 110 / 4

smisline prefix

Bus starter kit

Phases  
1 minimum, 4 maximum

Number of modules  
6 minimum, 110 maximum

